



(GB) Repair regulations
CF500 Cylinder disassembly

(GB) **CF500 Cylinder disassembly**

- You have received a cylinder from Cargo Floor as an exchange for a defective cylinder. Please follow the instructions given below carefully to exchange the part correctly and as quickly as possible.
- The total disassembly/assembly time for the old/new cylinder shall not exceed 4 hours. Each additional cylinder will involve 1 hour's work.
(This represents a maximum of 6 hours for a complete set of cylinders = 3 units.)

| Required parts | Supplied | Reuse |
|--------------------------------------|----------|-------|
| CF500 cylinder | 1 | |
| Bolt M16 x 90 | 12 | |
| Tab washer M16 | 12 | |
| Rod guiding block | 1 | |
| Box | 1 | |
| Instructions for shipping parts back | 1 | |

- Tools required:
 - 3.5 mm screwdriver
 - Open-end spanner 10;
 - Open-end spanner 17 (2x);
 - Open-end spanner 19;
 - Open-end spanner 22;
 - Open-end spanner 24;
 - Open-end spanner 32;
 - Open-end spanner 36;
 - Open-end spanner 41;
 - Open-end spanner 46;
 - Torque wrench 0-50 Nm with cap 13
 - Torque wrench 0-200 Nm with cap 24
 - Copper grease
 - Steel brush;
 - Hammer;
 - Chisel.

Important information:

- When possible draw in the cylinders to prevent damages to the cylinder rods;
- The **warranty** will not apply if prior permission has not been obtained from Cargo Floor B.V.! The system number must be mentioned in all correspondence when under warranty;
- Always replace, when exchanging a cylinder, the supplied rod guiding set.
- The pump and electrical installation must always be switched off and the hoses and/or pipes between the pump and the Cargo Floor drive unit must have been disconnected;
- Also disconnect the electrical connection (light coil of the lorry);
- When the cylinders are being installed, the floor must be **empty**! Should this be impossible, the bolts must be tightened immediately after having used the torque wrench;
- Check the oil level after assembly;
- Check/replace the pressure filter!
- When sending back "defective" cylinders, follow the instructions given!

Cargo Floor B.V.
P.O. Box 271
7740 AG COEVORDEN
The Netherlands

Phone: +31 (0)524-59 39 00
Fax: +31 (0)524-59 39 99

www.cargofloor.nl
info@cargofloor.nl



Remove the plug caps from the coils of the GS02 (on=unload/off) and G02 (load) valves. Use a 3.5 mm screwdriver.

P-pipe disassembly

Position an oil trough under the valve block to catch any leak-off oil.

First, loosen the coupling screw on the front of the control valve; figure 1.0 (spanners 32 + 36).

Disassemble the pressure filter of the support (4 x M8 x 25, spanner 13) and remove the pressure filter with the P-pipe. Ensure that dirt cannot enter the pipe when putting it aside. Cap off the outlet of the valve to avoid contamination; figure 3.0.

Figure 1.0



Figure 2.0



Figure 3.0



T-pipe disassembly

Position an oil trough under the valve block to catch any leak-off oil.

First, loosen the coupling screw on the side of the control valve; figure 4.0 (spanners 41 + 46).

Next, loosen the bolts of the pipe bracket (2 x M6 x 40, spanner 10) and remove the pipe.

Ensure that dirt cannot enter the pipe when putting it aside. Cap off the outlet of the valve to avoid contamination; figure 6.0.

Figure 4.0

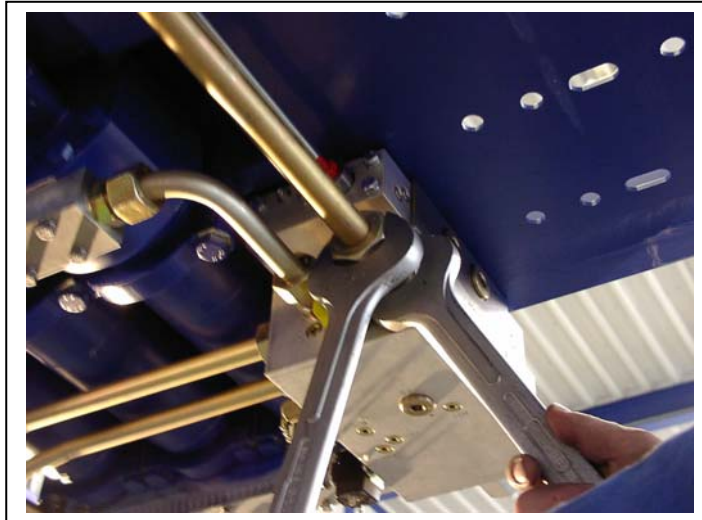

Figure 5.0



Figure 6.0



Threaded rod disassembly

Remove the bolts from the command lips; figure 7.0 (M6 x 50, 2 x spanner 10).

Loosen the nut on the mechanical front control plunger (\varnothing 16 mm) of the control valve. To achieve this, position a spanner 17 on the back of the control valve and another spanner 17 on the front of the valve; figure 8.0. Turn the threaded rod and remove it from the mechanical pre steering plunger; figure 9.0. If this is not possible because the spring is pressing against the command lip, first turn the 2 M10 (2 x spanner 17) nuts slightly back (away from the command lip).

Figure 7.0



Figure 8.0

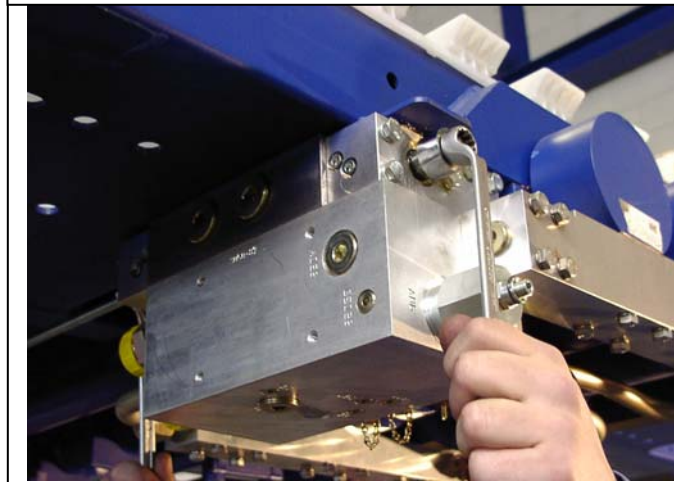
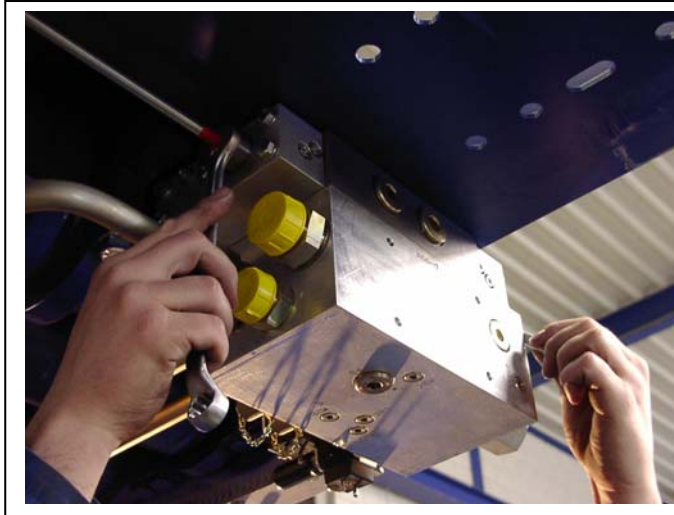

Figure 9.0



Remark/Warning:

If the bolt on the back turns loose, but not the nut on the threaded rod, screw a bolt without a spacer in the mechanical pre steering plunger (Ø 16 mm, figure 10.0). Next, position a spanner 13 on the flat sides of the cartridge. The bolt ensures that the hollow shaft cannot be compressed when a spanner is positioned on the flat sides.

Figure 10.0

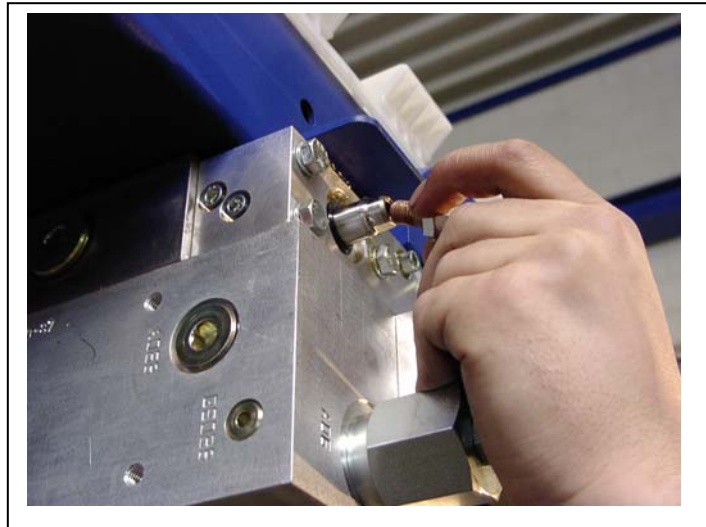

Removing the G02 cartridge (load)

First, loosen the nut with which the coil has been mounted (spanner 19) and remove the coil (to ensure that the pins and the cartridge are not damaged); figure 11.0.

Next, unscrew the cartridge from the control valve (spanner 22).

Seal the opening again using the GS021 plug, which can be found next to the test connections in the block (spanner 24) (the code can be found on the valve); figures 12.0 and 13.0.

Figure 11.0

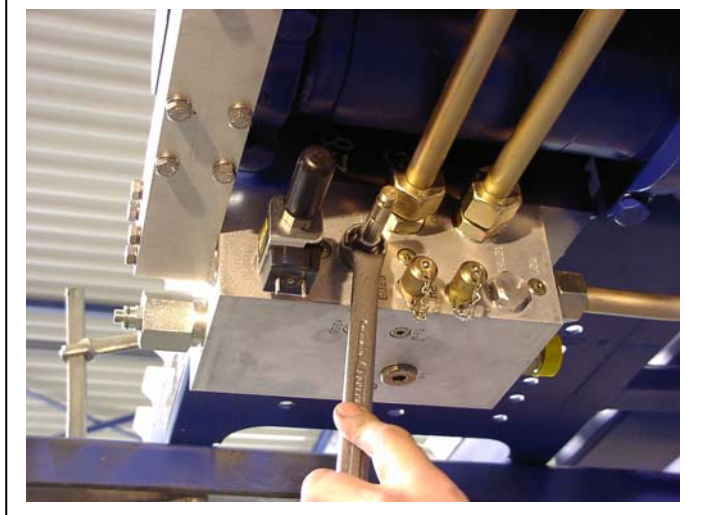

Figure 12.0

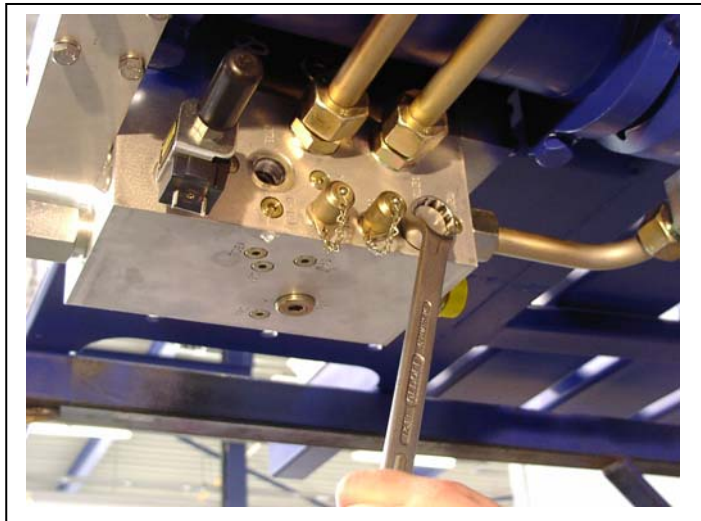
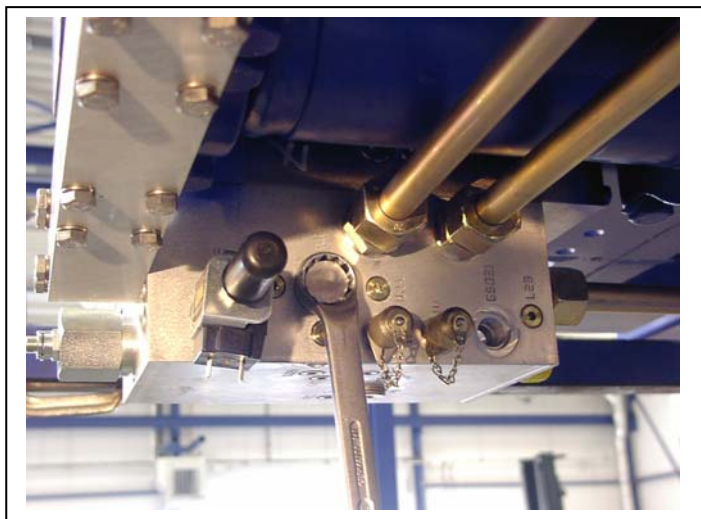

Figure 13.0



Removing pipes

Loosen pipe P5 (see: the pipes figure below and also the assembly instructions, page H1, hydraulic diagram and the instructions of use) on the side of the control valve (channel 4); spanners 32 + 36.
Next, loosen the pipe on the side of the common rail (rod side of the cylinder).
Remove the 3/4"-20 screw-in coupling from the control valve and cap off the channel.

Loosen pipe S5 on the side of the control valve (channel A1); spanners 32 + 36.
Next, loosen the pipe on the side of the common rail (bottom side of the cylinder).
Cap off the A1 openings and the openings in the common rail.

Slightly loosen the coupling screw of pipe Q5 on the side of the control valve (channel A1); spanner 32/36 (leave the nut positioned but in such a way that the pipe can turn in the coupling).
Next, loosen the nut on the side of the common rail (rod side of the cylinder) in such a way that it can be unscrewed immediately manually). The pipe will remain attached to the valve block to ensure it can be presently used as a "handle"; figure 15.0.

Next, loosen the bolts of the common rail bottom side connection (4 x M8 x 75, spanner 13). Note: remove 3 bolts and allow the last bolt to somewhat remain in the thread.
Now, support the valve with your hand and unscrew the last M8 bolt from the common rail.
Subsequently, loosen the coupling screw on the common rail rod side.
The control valve can now be removed.
Cap off the channels of both common rails; figure 16.0

Figure 13.1



Figure 14.0



Figure 15.0

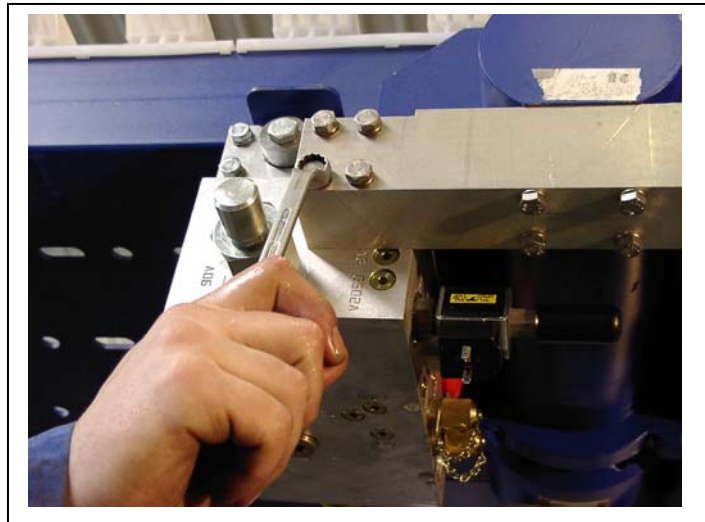

Figure 16.0



Common rail disassembly

First, disassemble the common rail on the rod side of the cylinder. You have to loosen the 12 M8 x 75 bolts (spanner 13); figure 17.0. The common rail can now be removed.

Cover or cap off the channels of the common rail and of the cylinders to prevent dirt entering the system; 18.0.

Next, disassemble the common rail at the bottom of the cylinder. You have to loosen the 12 M8 x 75 bolts (spanner 13); figure 19.0. The common rail can now be removed, figure 20.0.

Cover or cap off the channels of the common rail and of the cylinders to prevent dirt entering the system; figure 21.0.

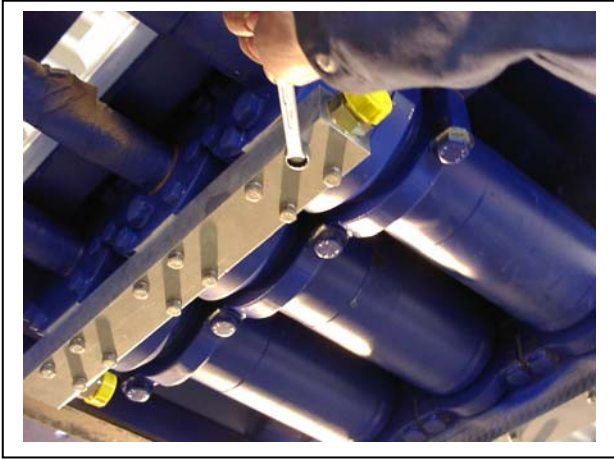

Figure 17.0



Figure 18.0



Figure 19.0

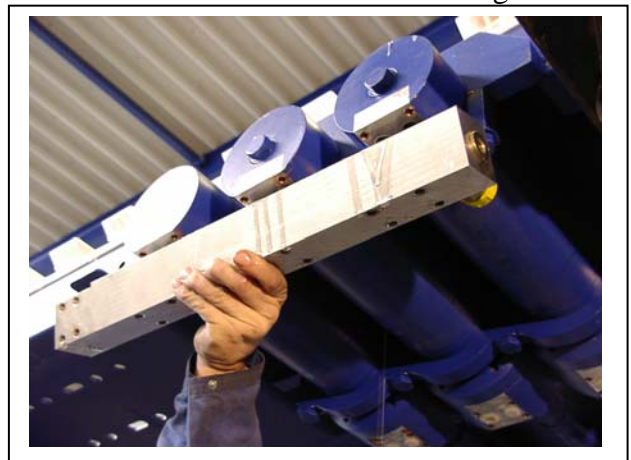

Figure 20.0



Figure 21.0

Cylinder disassembly, (note: this should be done by 2 persons)

Hit back the vertical edge of the tab washers of the bolts (M16 x 90) of the clamping plate on the bottom (2x), of the triple clamping plate on the rod side (4x), of the clamping plate located at the frame foot of the cylinder concerned (4x) and of the rod guide set (2x). Use a hammer and a chisel for this; figures 22.0 and 23.0.

Figure 22.0

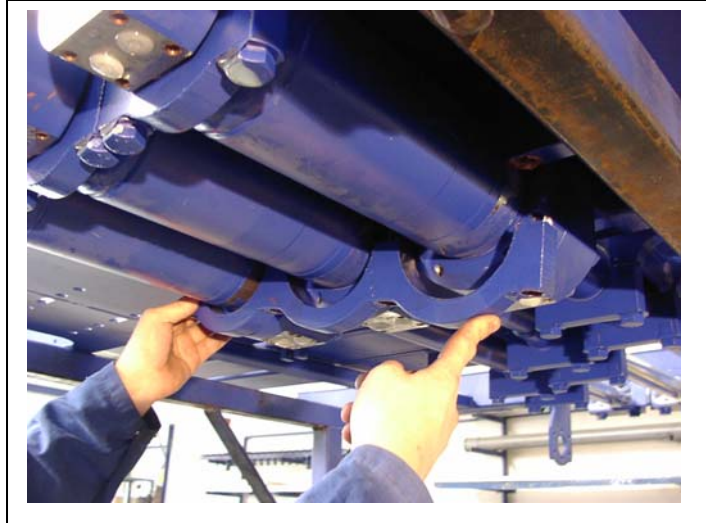

Figure 23.0



The bolts of the triple clamping plate (4 x M16 x 90) can be unscrewed and removed; figure 24.0.

Figure 24.0



Next, the bolts of the rod guide can be unscrewed and removed
Now loosen the bolts of the single cylinder (bottom); figure 25.0.

Figure 25.0



Do not remove these bolts yet but ensure that these can be unscrewed manually.
Next, loosen the bolts of the clamping plate of the frame foot; figure 26.0.

Figure 26.0



Remove one clamping plate and loosen the other bolts in such a way that they can be removed manually.

Next, **2 persons** should grab the cylinder (figure 27.0; you can also use a jack or a pit lift as an alternative) and remove the last bolts and clamping sleeves.

The cylinder can now be removed; figure 28.0.

Remove the rod guiding by unscrewing the 2 M16 bolts.

Figure 27.0



Figure 28.0



Cylinder assembly (note: this should be done by 2 persons)

When assembling the cylinder, all the seatings in which the cylinder falls and the thread on the piston rod must be cleaned well and must be greased using copper grease; figures 29.0 and 30.0.

Position the 2 clamping plates with the bolts (4 x M16 x 90 that have the tab washers) so that they are ready and within reach.

Figure 29.0



Figure 30.0



Warning:

Remove all caps before installation and ensure that the holes have been properly cleaned.

Also properly clean the flat side on which the common rail will be installed.

Figure 31.0



Slide the plastic rod guiding on the piston rod.

Two persons should lift the cylinder and position it at the correct location. Ensure that the thread is correctly positioned in the plate. It must be positioned approximately in the centre of the supporting plate (this is the sleeve that has been mounted on the frame foot); figure 32.0.
First, mount a clamp around the piston rod at the frame foot and tighten both bolts a few turns; figure 32.0.

Figure 32.0

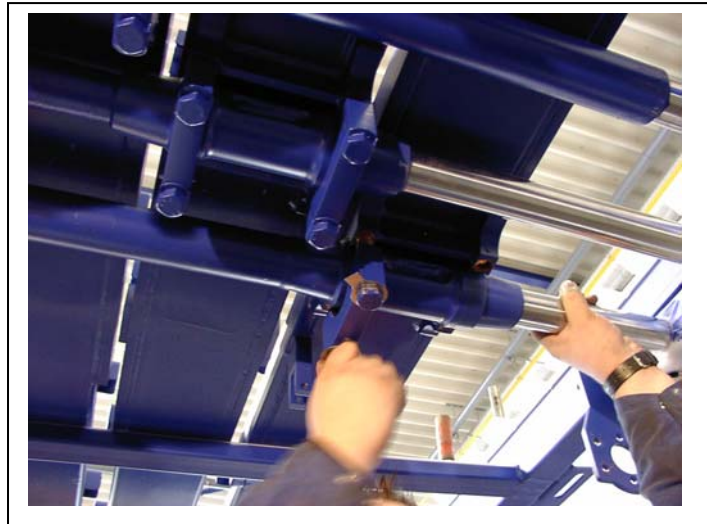

Figure 33.0



Next, install the single clamping sleeve on the cylinder bottom and tighten both bolts a few turns; figure 33.0.

Now, install the triple clamping plate and the rod guide. Do not yet tighten the bolts.

Check whether the slit that is located in the sleeve around the piston rod is in a horizontal position; figure 34.0.

Figure 34.0

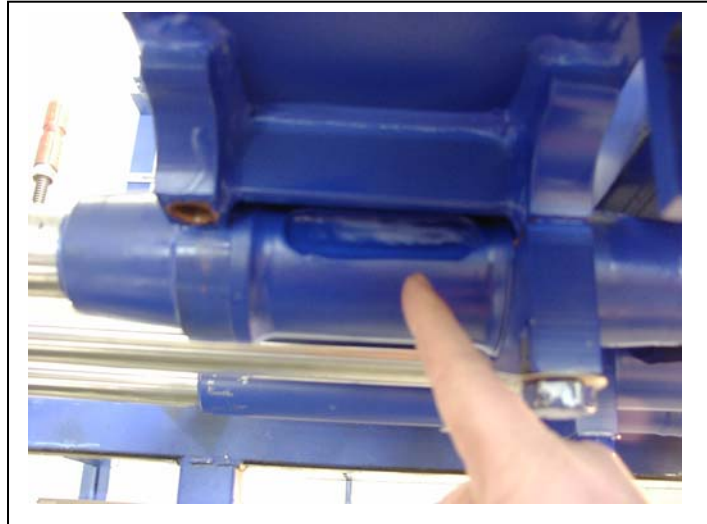

Install a trimmed tab washer under the bolt head of the single clamping plate. (Refer to figure 35.0.)

Figure 35.0

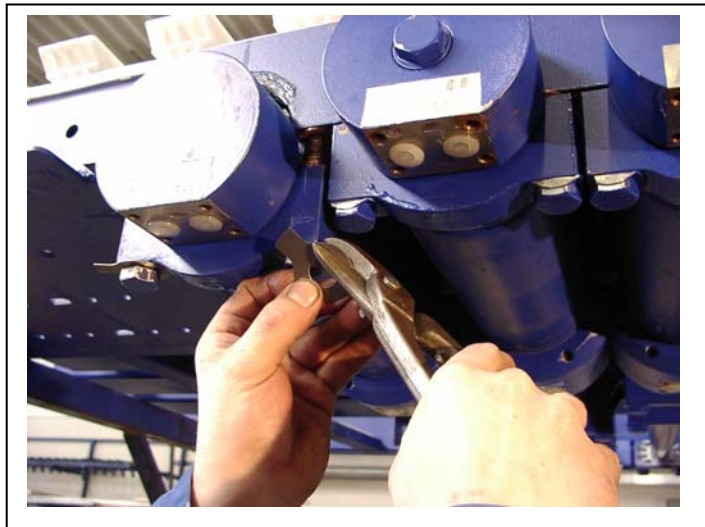

Turn over the protruding tab and hit one side of the ring against the surface of the hexagon-head bolt (refer to figure 36.0).

Figure 36.0



Remove all caps from the cylinders and from the common rail.

Next, pull the cylinder as close as possible in the sleeves by tightening the bolts but also ensure that the cylinder is not yet clamped.

Check whether the surfaces of the common rail are all in parallel to each other.

You can use the common rail for this; figure 37.0.

Figure 37.0



Warning:

Check that the surfaces on which the common rail is being mounted are really clean and that all plugs have been removed.

Figure 38.0



If they are correctly positioned, mount the common rail on both sides; figure 38.

To correct the position of the cylinder, should this be necessary, you can position a spanner 17 on the bolts of the cover of the cylinder and turn it. Note: Do not position a spanner on the (hexagon) plug next to the piston rod. It is very easy to damage the piston rod should the spanner slip; figure 39.0

Figure 39.0

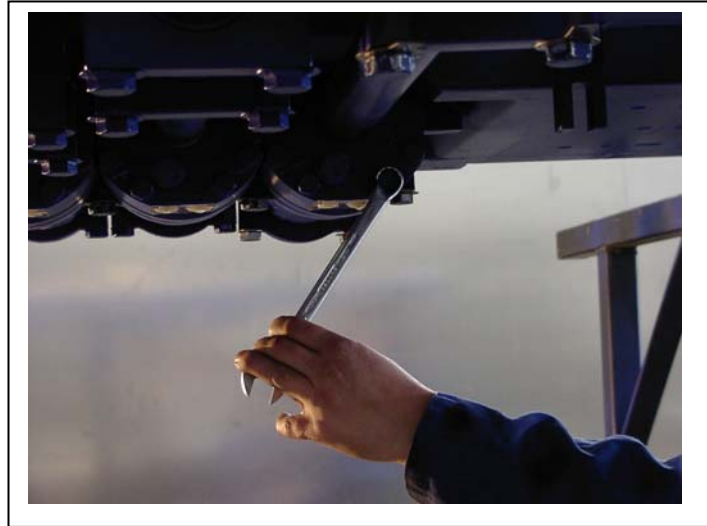

Tighten all bolts (12 x M16 x 90).

Tighten the cylinder (6x) and frame foot (4x) bolts using 150 Nm (spanner 24).

Tighten the plastic guiding set (2x) bolts using 100 Nm (spanner 24); figures 40.0 and 41.0.

Ensure that the bolt heads of the cylinder, frame foot and rod guide fastenings are all positioned pointing towards the tap washer with their flat sides to ensure that the washer rests against the flat side.

Figure 40.0



Figure 41.0



Tighten the bolts of the common rails (24x) using 30 Nm (spanner 13).

Valve block assembly

The assembly of the valve block should be performed in the reverse order of the disassembly process. Please ensure that all caps from the oil channels have been removed when carrying out the assembly. Check that the channels are clean.

Use copper grease for the assembly in relation to the bolts. Tighten the bolts (4 x M8 x 75, spanner 13) using 30 Nm. Check whether the right choke is under the PB plug (refer to the arrow in figure 17.0) on the bottom of the control valve; figures 42.0 to 44.0.

Figure 42.0

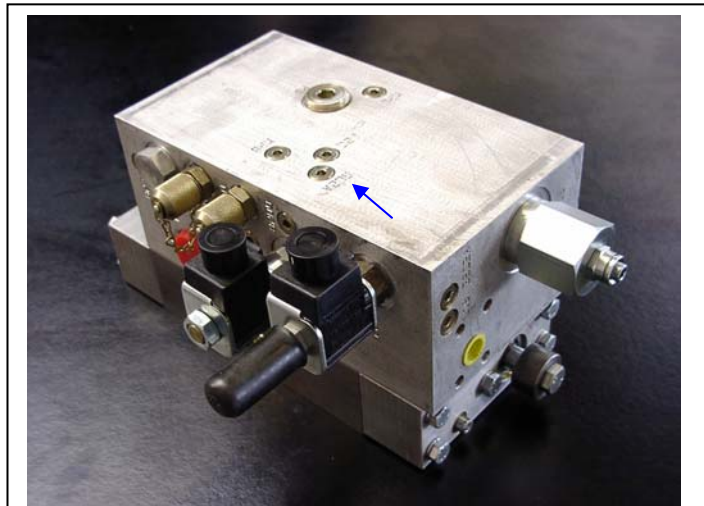

Figure 43.0

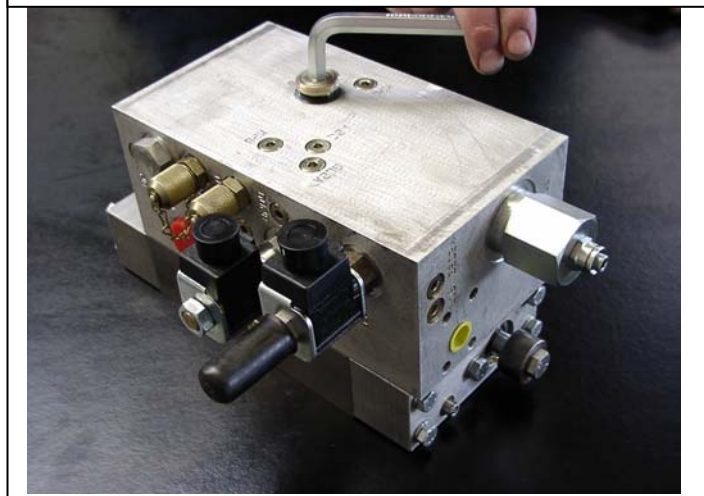
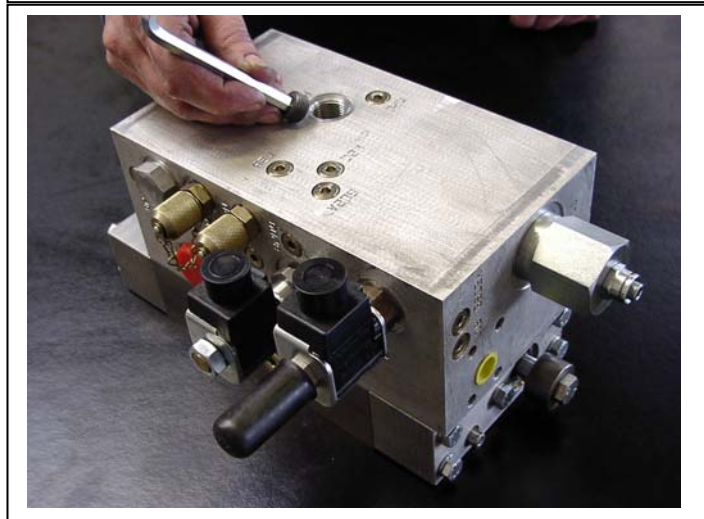

Figure 44.0



If it has not been installed, a choke must be installed.

You can transfer the choke from the disassembled block to the new block. You can also install the new choke that has been supplied. Ensure that the diameter of the hole agrees with the flow. Refer to the diagram below to obtain information about the size.

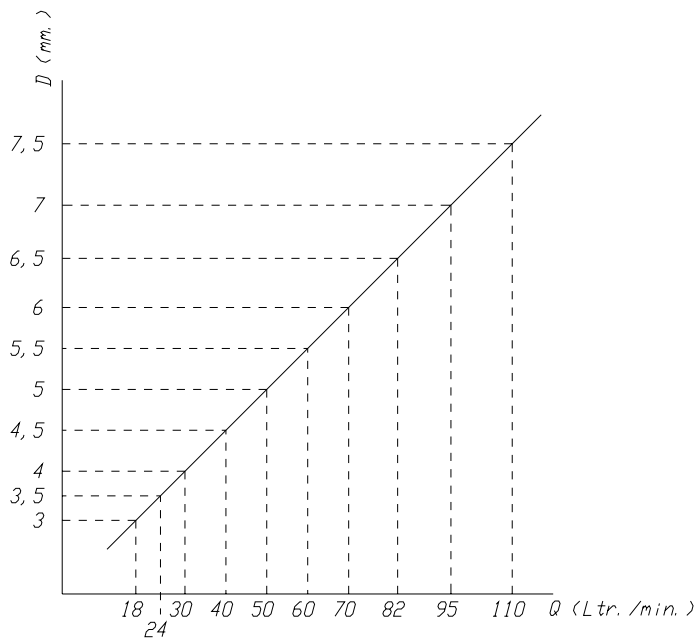
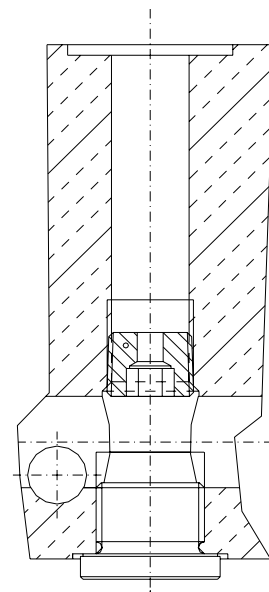

Figure 45.0



PB

Figure 46.0

Suspend the valve (with the short pipe installed) between the common rails on the bottom and on the rod side; figure 47. Turn the coupling screw on the screw-in coupling of the common rail on the rod side. Next, install the block on the common rail on the bottom using the 4 bolts (M8 x 75).

Figure 47.0



Install both the other pipes (P5 and S5) and, when everything has been installed, secure them. Tighten the 4 bolts (M8 x 75) of the common rail with a torque wrench (30 Nm). Next, first install the G02 cartridge with coil and afterwards the GS02 cartridge with coil. Connect the plug caps again.

Remark:

NOTE! The plug cap with the red LED should be position on the coil of the GS02 cartridge and the plug cap with the yellow LED should be positioned on the coil of the G02 cartridge. (Refer to figure 48.0.)

With the DEUTSCH connector the black plug should be used for the GS02 coil and the grey plug for the G02 coil.

Checking for leakage

After the control valve is connected, the threaded rod has to be mounted.

Before the threaded rod is adjusted the system has to be checked for leakage.

In order to do this the bolts behind the springs have to be turned so far away that the commandlip does not put pressure on the springs. This will cause the system to go into overpressure. When the threaded rod is pulled out (plunger of the control valve is 12 mm out) and all three cylinders are positioned out, there will be pressure on the bottom of the cylinders.

When the Common Rail on the bottom side is without leakage, the threaded rod can be pushed in.

When the cylinders are pulled in, the pressure will rise at the rod side.

If the Common Rail at the rod side is also without leakage, one can adjust the threaded rod.

Attention! Do not test both directions longer than 5 seconds, this due to the development of heat in the oil. Hot oil can melt the seals.

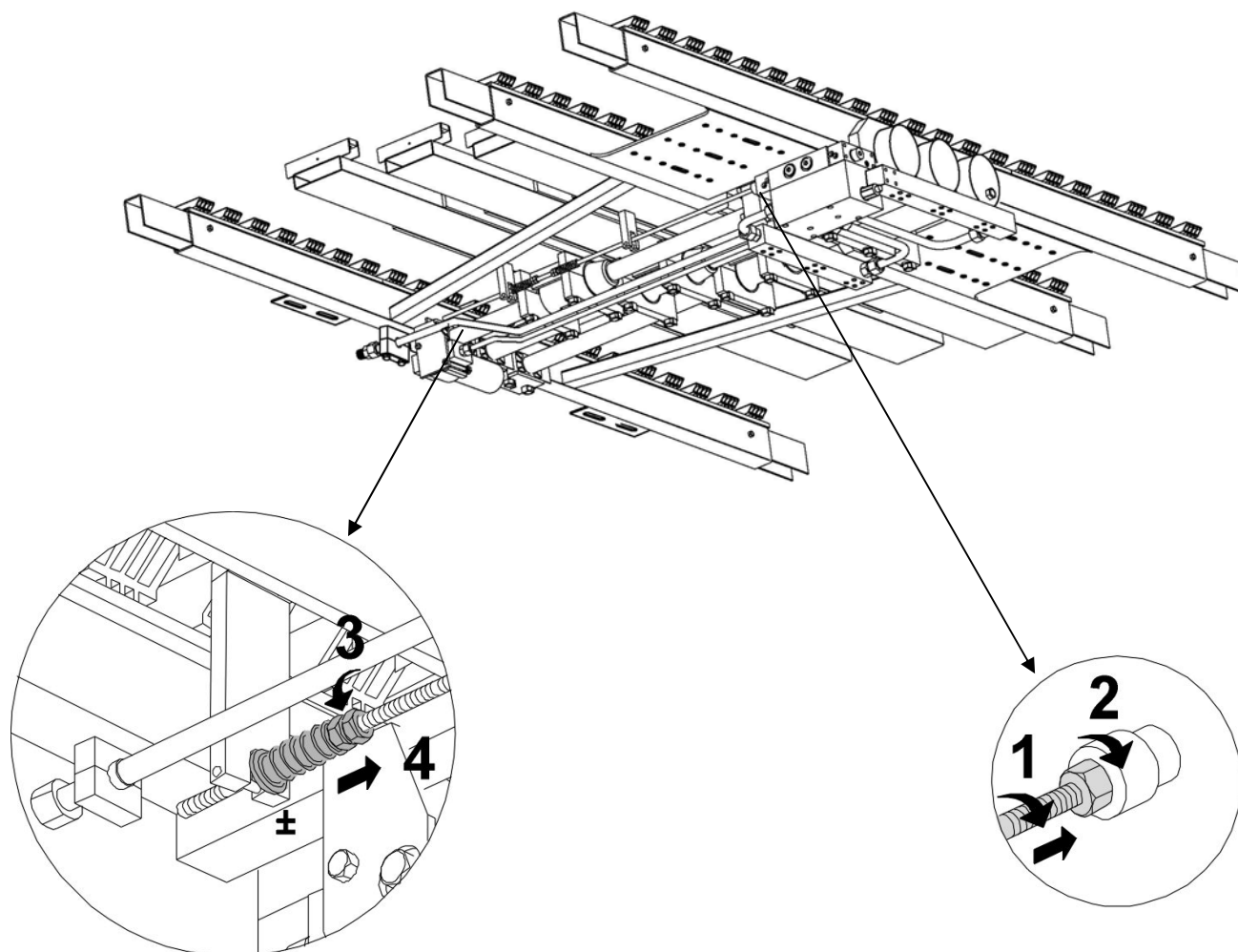

ADJUSTING THE CIRCULATION VALVE

The Cargo Floor systems are already adjusted and tested when you take them over. In certain circumstances (moved combination valve) it may be necessary to check the adjustment. You can do this as follows:

Necessary tools:

- 2x spanner 17;
- High viscosity oil;
- Copper grease;
- Steel brush.

Check that the wire rod is fastened securely to the switchover valve plunger (see figure 33). If not, then screw the wire rod (1) as far as possible into the plunger and secure this with the contra nut (2) (spanner size 17).

Loosen nuts 3 and 4 (spanner size 17) and move these about 3 cm in the direction of the switchover valve. Now switch the pump on. The system will stop now at the point where the command lip no longer operates the switchover valve. Switch off the pump.

Now push the wire rod 1 in until the spacer ring 2 touches the switchover valve.

Tighten nuts 3 and 4 so that the spring is fully tensioned, and secure them by tightening them against one another. Repeat this procedure for the other side.

N.B. It is worthwhile spreading some copper grease on the wire rod 1.

Once everything has been connected, test whether the system operates correctly. Test both loading and unloading during a few strokes and verify that all pipes are leakage-proof.

Guarantee

If you are of the opinion that the replacement in question should fall under the guarantee, then you must comply with a number of conditions. The defective component must be returned to us by prepaid post. A copy of the Cargo Floor packing slip for the new component must be included in the package. This packing slip must include the following information: the Cargo Floor system number, the number of articles which are being returned with their associated article numbers and a description of the nature of the failure. In addition you must include the name and the telephone number of the contact person within your company. If these conditions have not been met within one month of receipt, then we can no longer process your guarantee application.